

International
IR Rectifier

PRELIMINARY

PD - 5.067A
GA150TD120U

"HALF-BRIDGE" IGBT DOUBLE INT-A-PAK

Ultra-Fast™ Speed IGBT

Features

- Generation 4 IGBT technology
- Standard: Optimized for minimum saturation voltage and operating frequencies up to 10kHz
- Very low conduction and switching losses
- HEXFRED™ antiparallel diodes with ultra- soft recovery
- Industry standard package
- UL approved

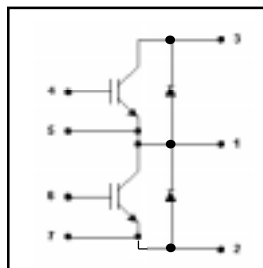

$V_{CES} = 1200V$
 $V_{CE(on)} \text{ typ.} = 2.4V$
@ $V_{GE} = 15V, I_C = 150A$

Benefits

- Increased operating efficiency
- Direct mounting to heatsink
- Performance optimized for power conversion: UPS, SMPS, Welding
- Lower EMI, requires less snubbing

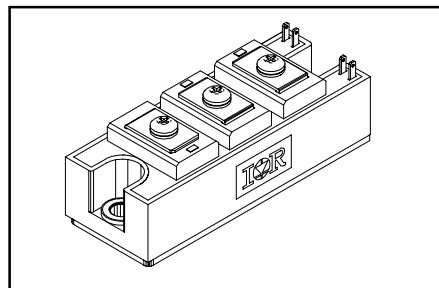

Absolute Maximum Ratings

	Parameter	Max.	Units
V_{CES}	Collector-to-Emitter Voltage	1200	V
$I_C @ T_C = 25^\circ C$	Continuous Collector Current	150	A
I_{CM}	Pulsed Collector Current ^①	300	
I_{LM}	Peak Switching Current ^②	300	
I_{FM}	Peak Diode Forward Current	300	
V_{GE}	Gate-to-Emitter Voltage	± 20	V
V_{ISOL}	RMS Isolation Voltage, Any Terminal To Case, $t = 1 \text{ min}$	2500	
$P_D @ T_C = 25^\circ C$	Maximum Power Dissipation	780	W
$P_D @ T_C = 85^\circ C$	Maximum Power Dissipation	406	
T_J	Operating Junction Temperature Range	-40 to +150	$^\circ C$
T_{STG}	Storage Temperature Range	-40 to +125	

Thermal / Mechanical Characteristics

	Parameter	Typ.	Max.	Units
$R_{\theta JC}$	Thermal Resistance, Junction-to-Case - IGBT	—	0.16	$^\circ C/W$
$R_{\theta JC}$	Thermal Resistance, Junction-to-Case - Diode	—	0.20	
$R_{\theta CS}$	Thermal Resistance, Case-to-Sink - Module	0.1	—	
	Mounting Torque, Case-to-Heatsink	—	4.0	N·m
	Mounting Torque, Case-to-Terminal 1, 2 & 3 ^③	—	3.0	
	Weight of Module	400	—	g

Electrical Characteristics @ $T_J = 25^\circ\text{C}$ (unless otherwise specified)

	Parameter	Min.	Typ.	Max.	Units	Conditions
$V_{(BR)CES}$	Collector-to-Emitter Breakdown Voltage	1200	—	—	V	$V_{GE} = 0V, I_C = 1mA$
$V_{CE(on)}$	Collector-to-Emitter Voltage	—	2.4	2.9		$V_{GE} = 15V, I_C = 150A$
		—	2.2	—		$V_{GE} = 15V, I_C = 150A, T_J = 125^\circ\text{C}$
$V_{GE(th)}$	Gate Threshold Voltage	3.0	—	6.0		$I_C = 1.75mA$
$\Delta V_{GE(th)}/\Delta T_J$	Temperature Coeff. of Threshold Voltage	—	-11	—	mV/ $^\circ\text{C}$	$V_{CE} = V_{GE}, I_C = 1.75mA$
g_{fe}	Forward Transconductance ④	—	201	—	S	$V_{CE} = 25V, I_C = 150A$
I_{CES}	Collector-to-Emitter Leaking Current	—	—	2	mA	$V_{GE} = 0V, V_{CE} = 1200V$
		—	—	20		$V_{GE} = 0V, V_{CE} = 1200V, T_J = 125^\circ\text{C}$
V_{FM}	Diode Forward Voltage - Maximum	—	2.7	3.5	V	$I_F = 150A, V_{GE} = 0V$
		—	2.6	—		$I_F = 150A, V_{GE} = 0V, T_J = 125^\circ\text{C}$
I_{GES}	Gate-to-Emitter Leakage Current	—	—	500	nA	$V_{GE} = \pm 20V$

Dynamic Characteristics - $T_J = 125^\circ\text{C}$ (unless otherwise specified)

	Parameter	Min.	Typ.	Max.	Units	Conditions
Q_g	Total Gate Charge (turn-on)	—	1139	1709	nC	$V_{CC} = 400V, V_{GE} = 15V$
Q_{ge}	Gate - Emitter Charge (turn-on)	—	192	288		$I_C = 171A$
Q_{gc}	Gate - Collector Charge (turn-on)	—	377	566		$T_J = 25^\circ\text{C}$
$t_{d(on)}$	Turn-On Delay Time	—	414	—	ns	$R_{G1} = 15\Omega, R_{G2} = 0\Omega$
t_r	Rise Time	—	208	—		$I_C = 150A$
$t_{d(off)}$	Turn-Off Delay Time	—	552	—		$V_{CC} = 720V$
t_f	Fall Time	—	342	—		$V_{GE} = \pm 15V$
E_{on}	Turn-On Switching Energy	—	29	—	mJ	See Fig.17 through Fig.21
E_{off}	Turn-Off Switching Energy	—	32	—		
E_{ts}	Total Switching Energy	—	61	90		
C_{ies}	Input Capacitance	—	25630	—	pF	$V_{GE} = 0V$
C_{oes}	Output Capacitance	—	1139	—		$V_{CC} = 30V$
C_{res}	Reverse Transfer Capacitance	—	221	—		$f = 1MHz$
t_{rr}	Diode Reverse Recovery Time	—	186	—	ns	$I_C = 150A$
I_{rr}	Diode Peak Reverse Current	—	133	—		$R_{G1} = 15\Omega$
Q_{rr}	Diode Recovery Charge	—	12381	—	nC	$R_{G2} = 0\Omega$
$di_{(rec)M}/dt$	Diode Peak Rate of Fall of Recovery During t_b	—	2524	—	A/ μs	$V_{CC} = 720V$ $di/dt = 1260A/\mu\text{s}$

Details of note ① through ④ are on the last page

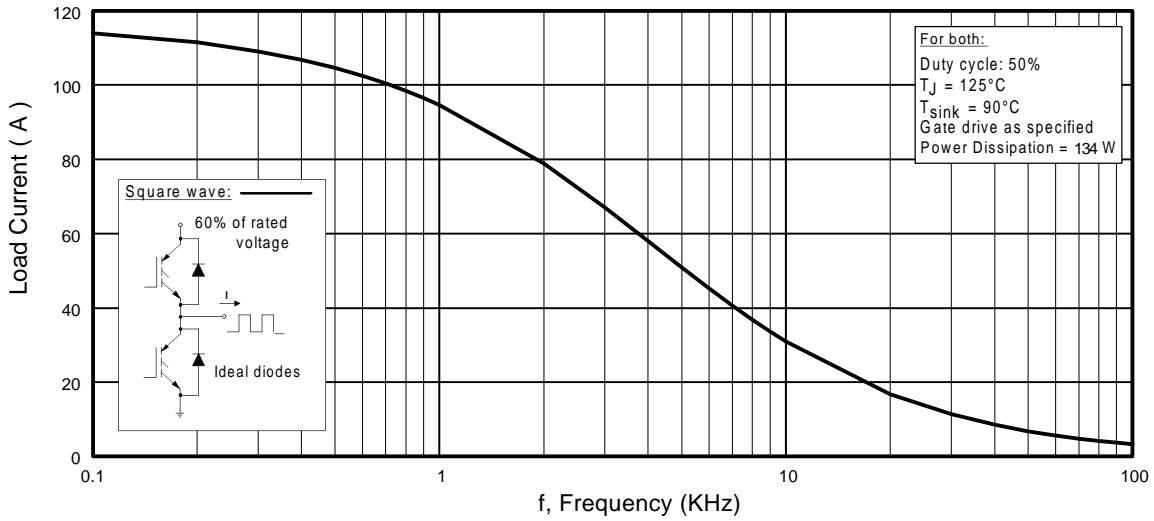

Fig. 1 - Typical Load Current vs. Frequency
 (Load Current = I_{RMS} of fundamental)

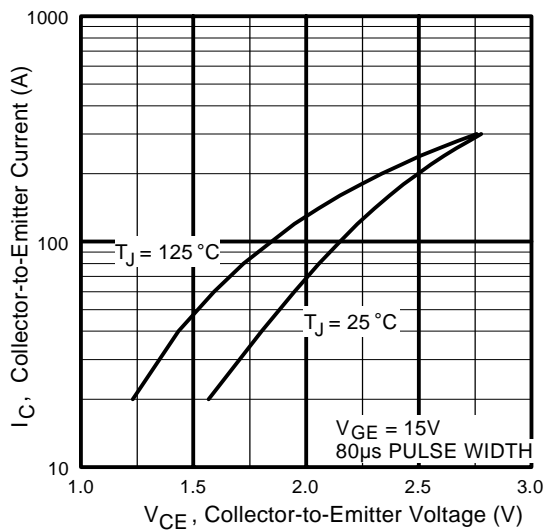

Fig. 2 - Typical Output Characteristics

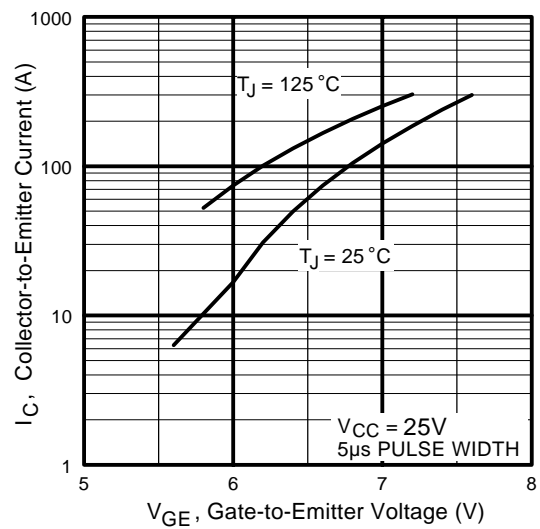

Fig. 3 - Typical Transfer Characteristics

GA150TD120U

International
IR Rectifier

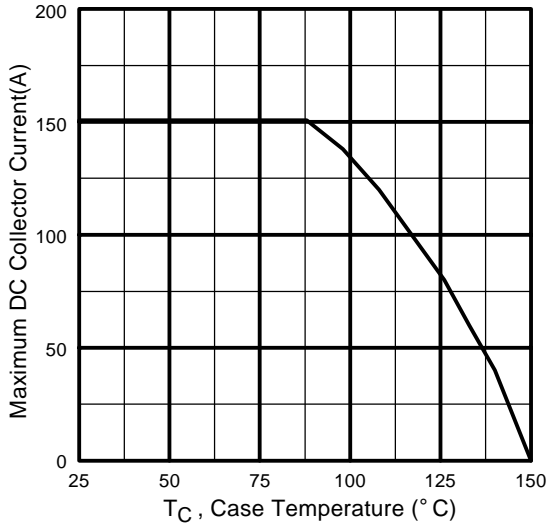

Fig. 4 - Maximum Collector Current vs. Case Temperature

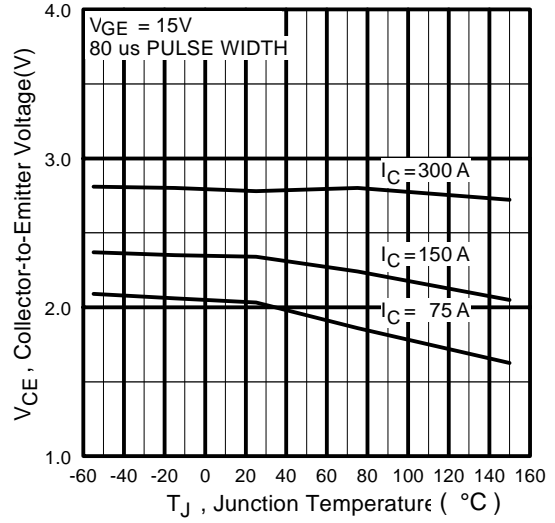

Fig. 5 - Typical Collector-to-Emitter Voltage vs. Junction Temperature

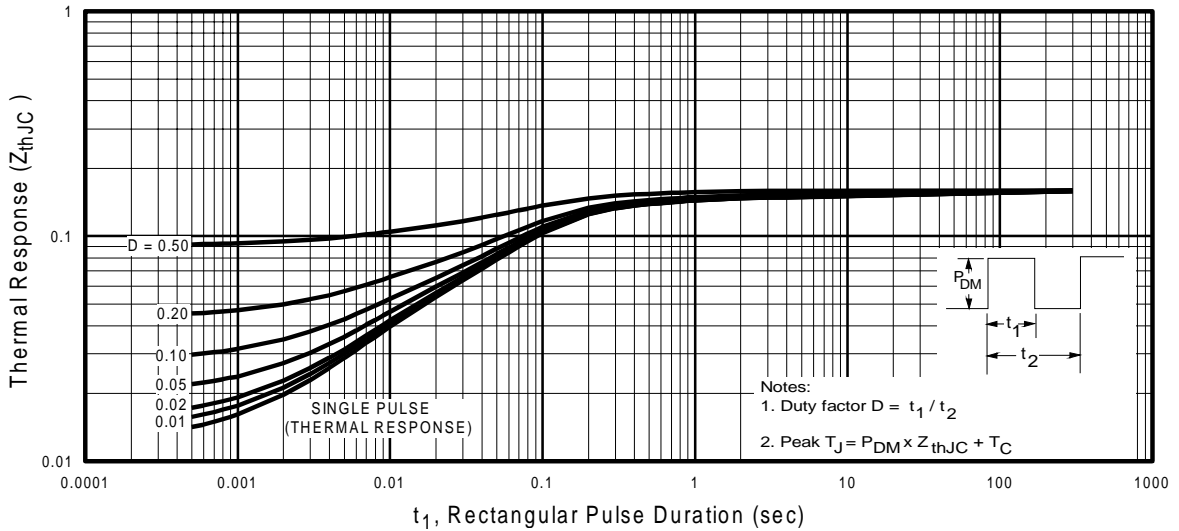

Fig. 6 - Maximum Effective Transient Thermal Impedance, Junction-to-Case

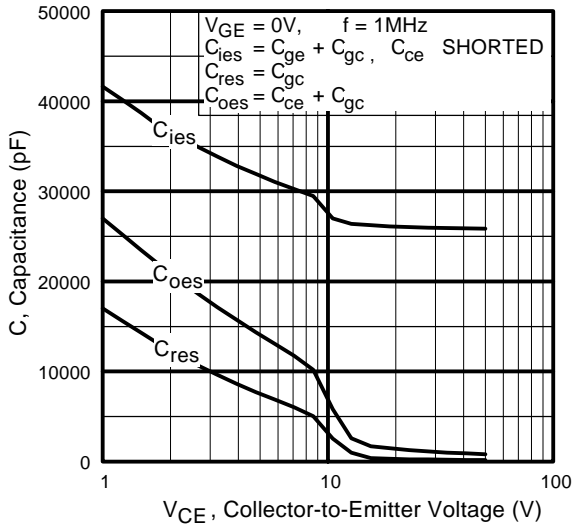

Fig. 7 - Typical Capacitance vs. Collector-to-Emitter Voltage

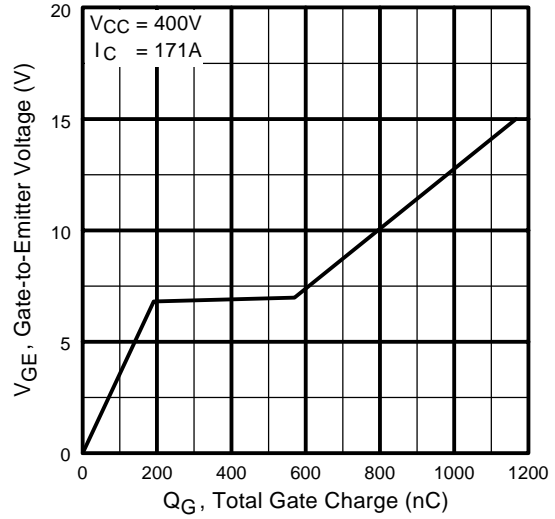

Fig. 8 - Typical Gate Charge vs. Gate-to-Emitter Voltage

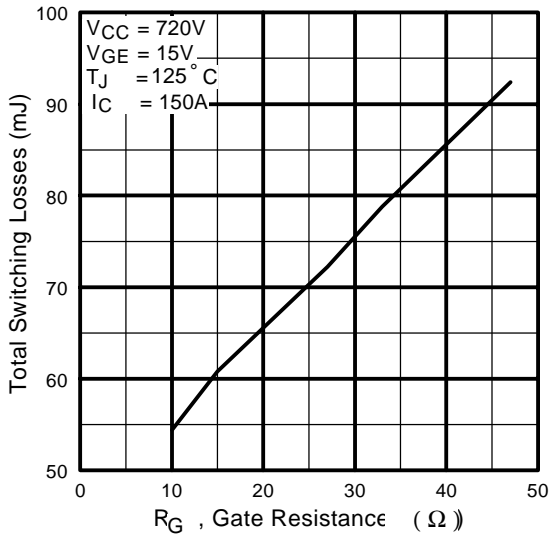

Fig. 9 - Typical Switching Losses vs. Gate Resistance

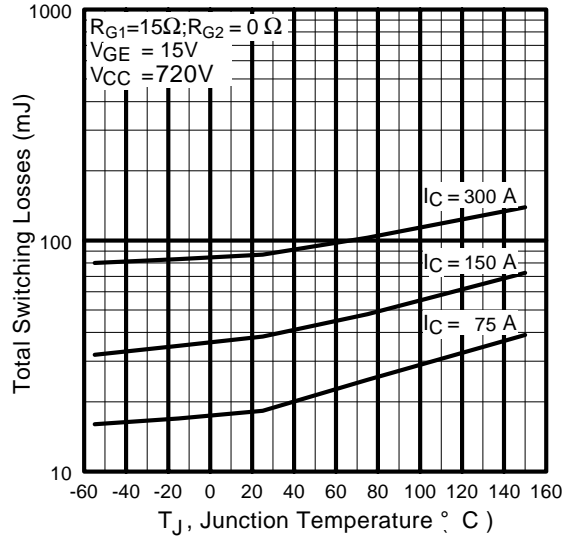

Fig. 10 - Typical Switching Losses vs. Junction Temperature

GA150TD120U

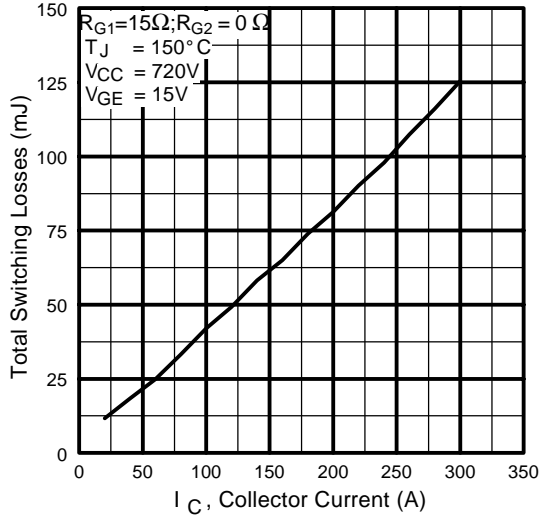

Fig. 11 - Typical Switching Losses vs. Collector-to-Emitter Current

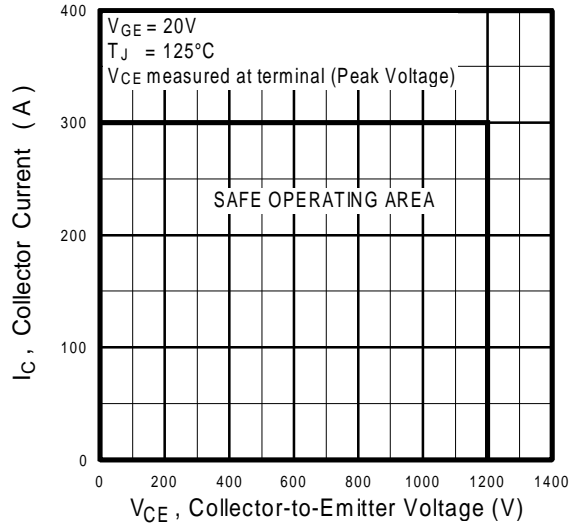

Fig. 12 - Reverse Bias SOA

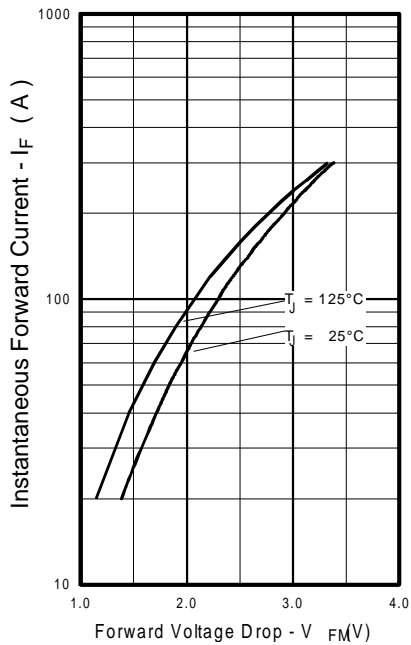

Fig. 13 - Typical Forward Voltage Drop vs. Instantaneous Forward Current

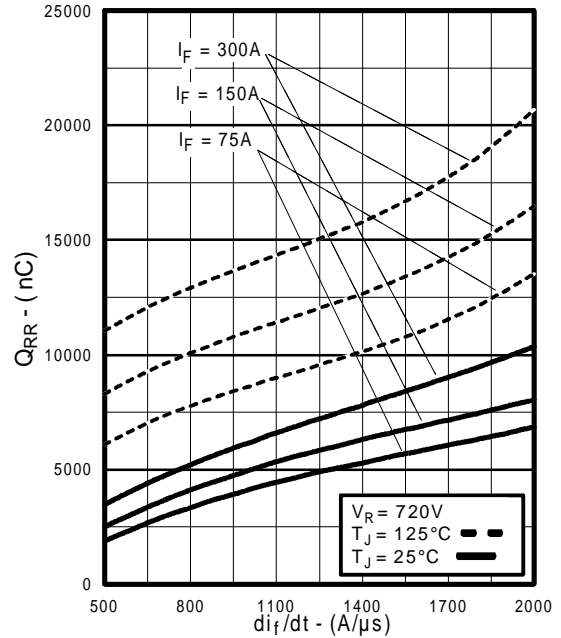

Fig. 14 - Typical Stored Charge vs. di_f/dt

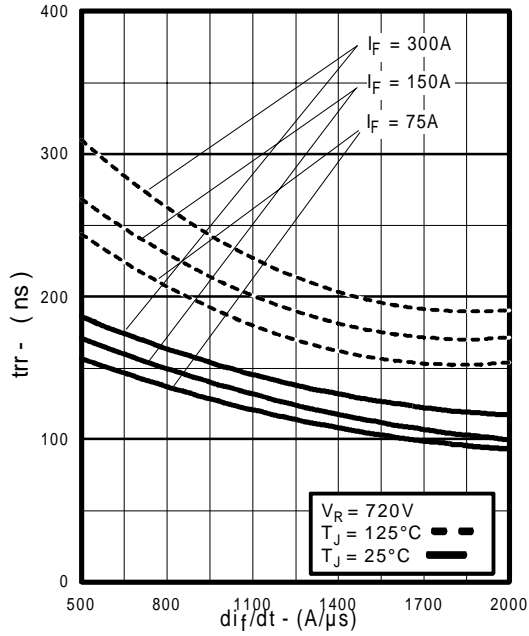

Fig. 15 - Typical Reverse Recovery vs. di_F/dt

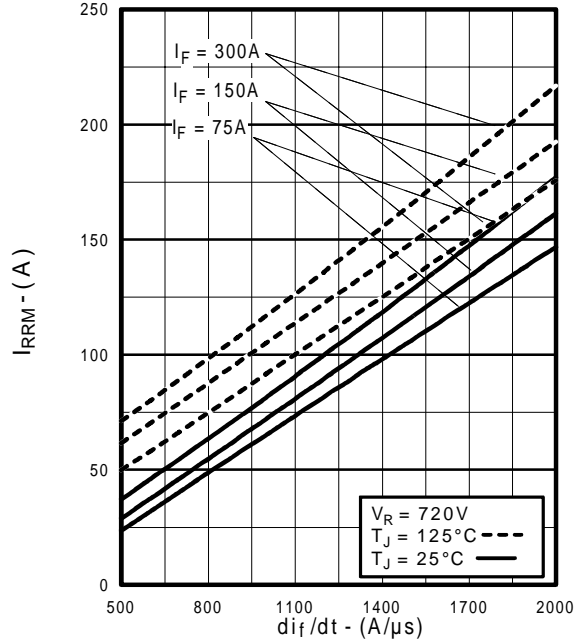

Fig. 16 - Typical Recovery Current vs. di_F/dt

GA150TD120U

International
IRF Rectifier

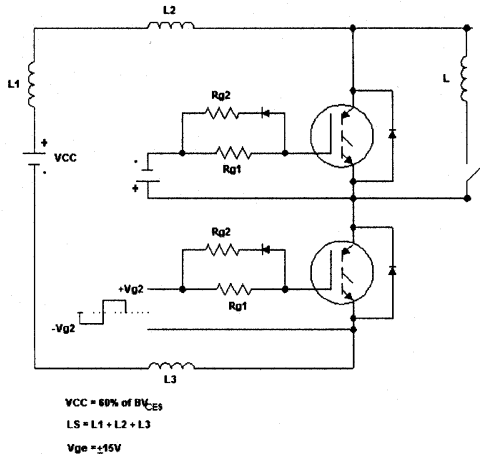

Fig. 17 - Test Circuit for Measurement of I_{LM} , E_{on} , $E_{off}(\text{diode})$, t_{rr} , Q_{rr} , I_{rr} , $t_{d(on)}$, t_r , $t_{d(off)}$, t_f

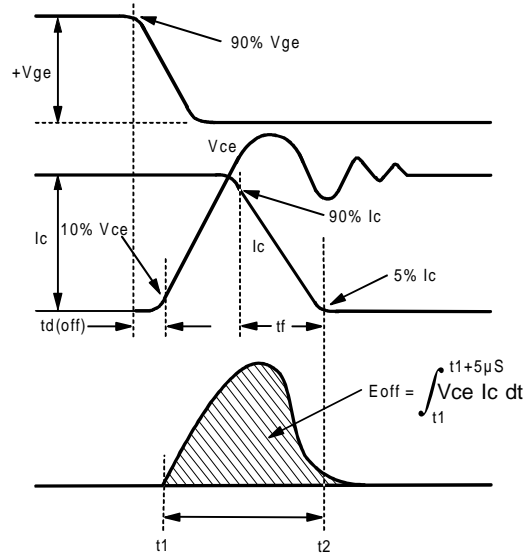

Fig. 18 - Test Waveforms for Circuit of Fig. 17, Defining E_{off} , $t_{d(off)}$, t_f

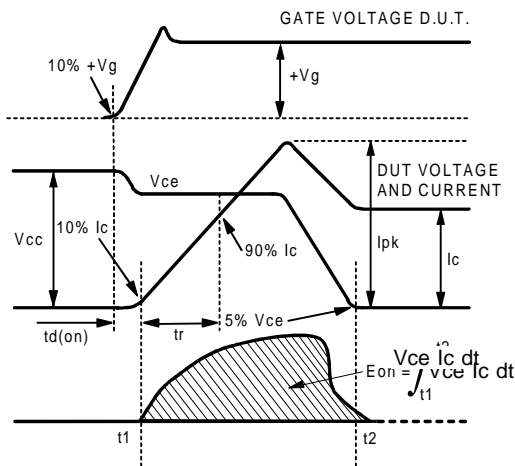

Fig. 19 - Test Waveforms for Circuit of Fig. 17, Defining E_{on} , $t_{d(on)}$, t_r

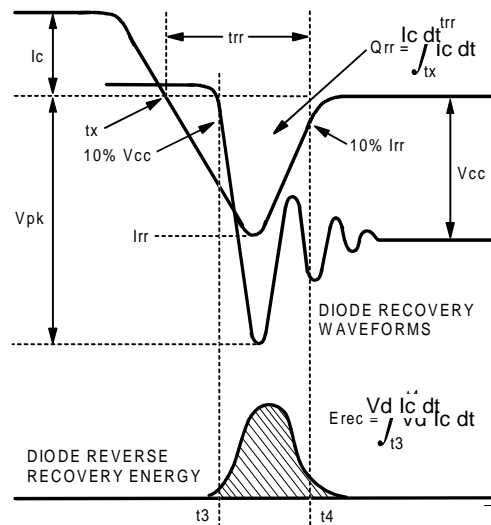

Fig. 20 - Test Waveforms for Circuit of Fig. 17, Defining E_{rec} , t_{rr} , Q_{rr} , I_{rr}

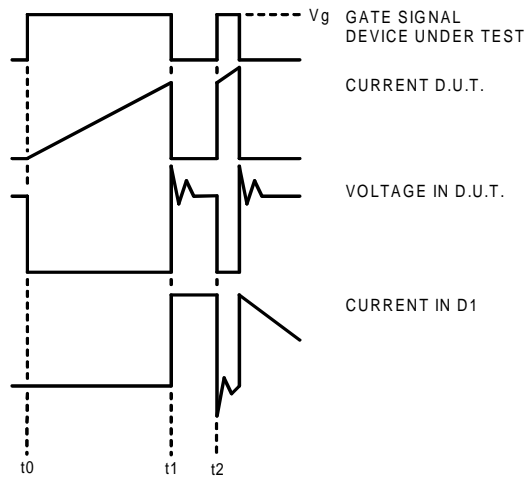

Figure 21. Macro Waveforms for Figure 17's Test Circuit

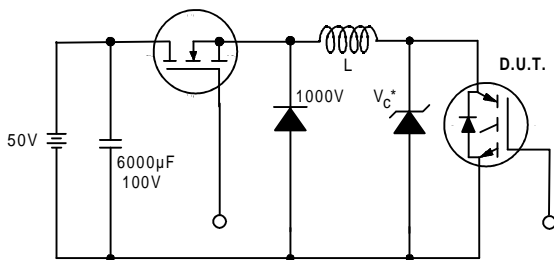

Figure 18. Clamped Inductive Load Test Circuit

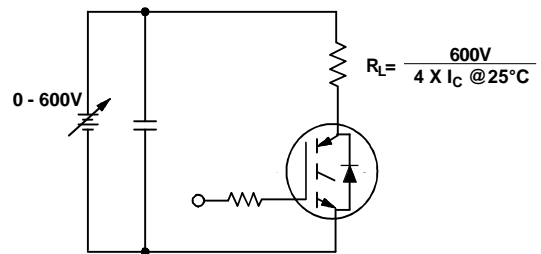

Figure 22. Pulsed Collector Current Test Circuit

GA150TD120U

International
IR Rectifier

Notes:

- ① Repetitive rating; $V_{GE} = 20V$, pulse width limited by max. junction temperature.
- ② See fig. 17
- ③ For screws M5x0.8
- ④ Pulse width 80 μ s; single shot.

Case Outline — DOUBLE INT-A-PAK

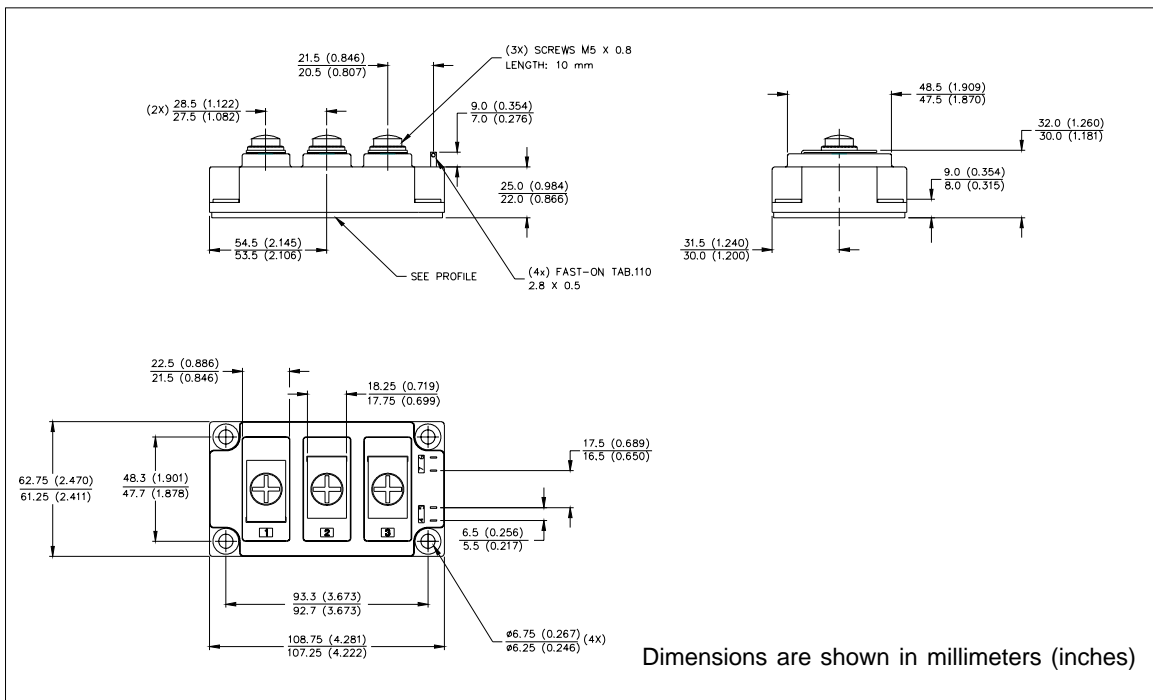

International
IR Rectifier

WORLD HEADQUARTERS: 233 Kansas St., El Segundo, California 90245, Tel: (310) 322 3331
EUROPEAN HEADQUARTERS: Hurst Green, Oxted, Surrey RH8 9BB, UK Tel: ++ 44 1883 732020
IR CANADA: 7321 Victoria Park Ave., Suite 201, Markham, Ontario L3R 2Z8, Tel: (905) 475 1897
IR GERMANY: Saalburgstrasse 157, 61350 Bad Homburg Tel: ++ 49 6172 96590
IR ITALY: Via Liguria 49, 10071 Borgaro, Torino Tel: ++ 39 11 451 0111
IR FAR EAST: K&H Bldg., 2F, 30-4 Nishi-Ikebukuro 3-Chome, Toshima-Ku, Tokyo Japan 171 Tel: 81 3 3983 0086
IR SOUTHEAST ASIA: 315 Outram Road, #10-02 Tan Boon Liat Building, Singapore 0316 Tel: 65 221 8371
<http://www.irf.com/> Data and specifications subject to change without notice. 3/98